



MISCELATORE / MIXER Art.Q16

SKY

Descrizione / Description

Miscelatore monocomando da incasso per doccia

Concealed shower mixer

Caratteristiche Tecniche

Cartuccia a dischi ceramici: Ø35

Trattamento superficiale: cromato







Technical Features

Cartridge ceramic discs: Ø35

Surface treatment: chrome-plated







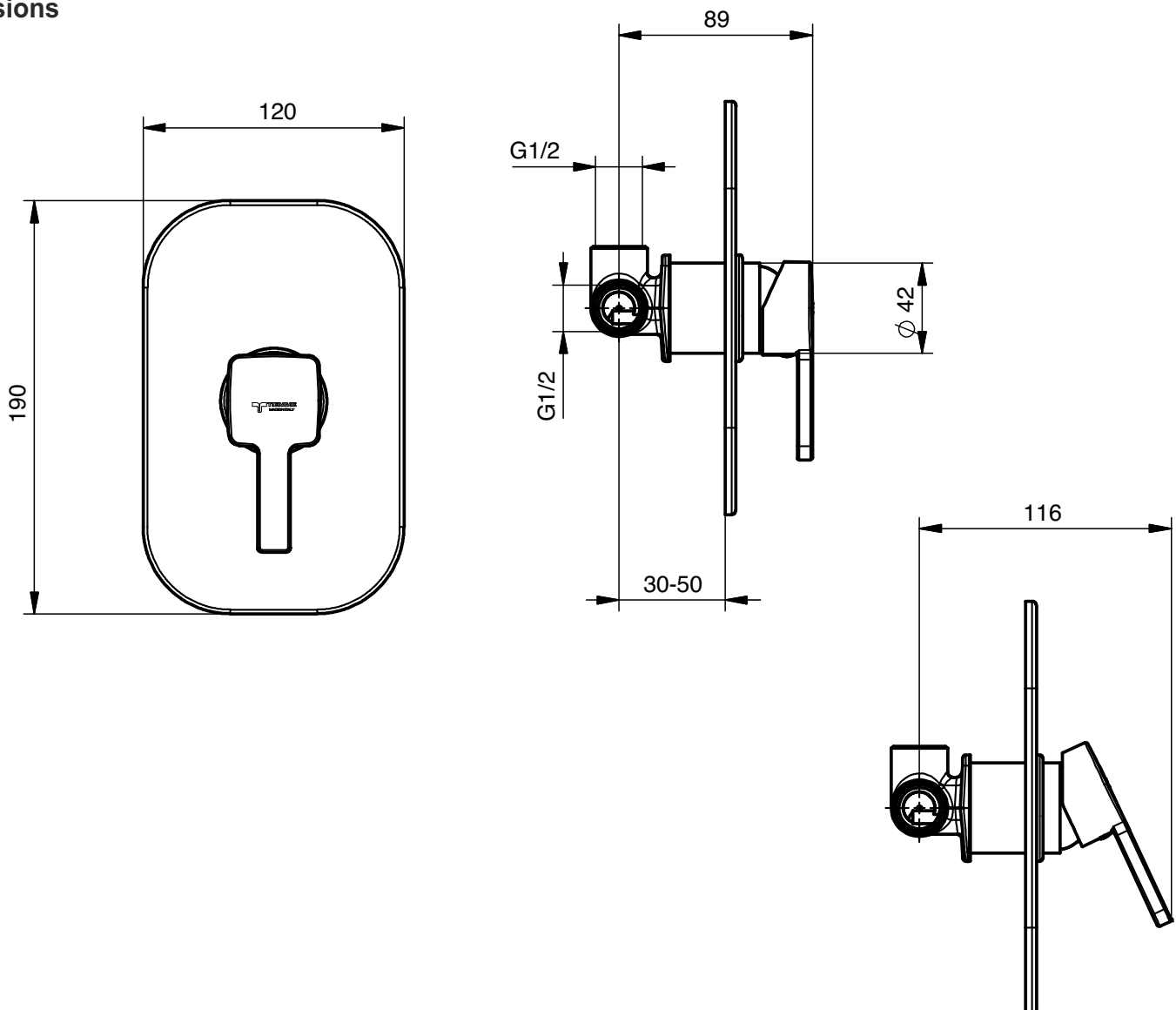

Finiture leva Lever finishings

	Cromo Chrome		Grigio platino Platinum Grey PG1 - RAL 7036
	Bianco White W1 - RAL 9003		Blu Night blue NB1 - RAL 5026
	Nero Black B1 - RAL 9004		Verde acqua Water blue WB1 - RAL 5021

Dimensioni Dimensions





Modello Model	Codice Code	Codice Prodotto Product Code	Descrizione Description	Finitura Finishing
SKY 	Q16	411490403	Miscelatore monocomando da incasso per doccia <i>Concealed shower mixer</i>	CROMO
SKY 	Q16 W1	411490424	Miscelatore monocomando da incasso per doccia, con leva colorata <i>Concealed shower mixer, with colored lever</i>	 RAL 9003
	Q16 B1	411490421		 RAL 9004
	Q16 NB1	411490422		 RAL 5026
	Q16 PG1	411490423		 RAL 7036
	Q16 WB1	411490425		 RAL 5021

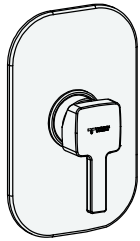

Cromo
Chrome

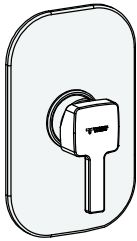

Bianco
White
W1 - RAL 9003

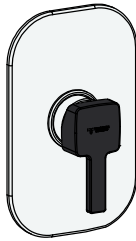

Nero
Black
B1 - RAL 9004

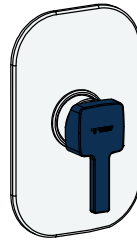

Blu
Night blue
NB1 - RAL 5026

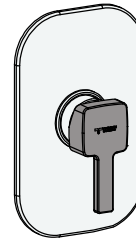

Grigio platino
Platinum Grey
PG1 - RAL 7036

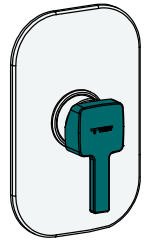

Verde acqua
Water blue
WB1 - RAL 5021

Accessori Accessories



cod. 411520405

TIEMME Raccorderie S.p.A.
Via Cavallera 6/A (Loc. Barco) - 25045 Castegnato (Bs) - Italy
Tel +39 030 2142211 R.A. - Fax +39 030 2142206
info@tiemme.com - www.tiemme.com

TIEMME Raccorderie S.p.A. si riserva di apportare modifiche in qualsiasi momento senza preavviso. È vietata qualsiasi forma di riproduzione, se non autorizzata.
TIEMME Raccorderie S.p.A. reserves the right to modify contents in any time without prior advise. Is forbidden any reproduction unless under TIEMME authorization