



Fly

MISCELATORE / MIXER Art.F09SST / F09SS

Descrizione / Description

F09SST

Miscelatore monocomando per lavabo con scarico
Wash basin mixer with pop-up

F09SS

Miscelatore monocomando per lavabo
Wash basin mixer







Caratteristiche Tecniche

Cartuccia a dischi ceramici: Ø35
Aeratore: M16x1
Attacchi flessibili: 3/8"
Trattamento superficiale: cromato

Technical Features

Cartridge ceramic discs: Ø35
Aerator: M16x1
Flexible connections: 3/8"
Surface treatment: chrome-plated

Finiture leva Lever finishings

	Cromo Chrome		Grigio platino Platinum Grey PG1 - RAL 7036
	Bianco White W1 - RAL 9003		Blu Night blue NB1 - RAL 5026
	Nero Black B1 - RAL 9004		Verde acqua Water blue WB1 - RAL 5021



Dimensioni Dimensions

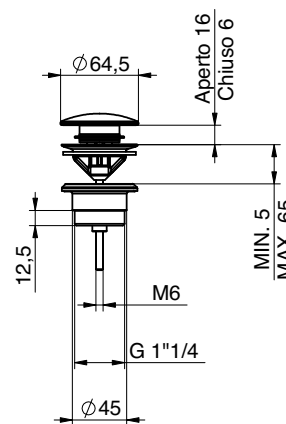
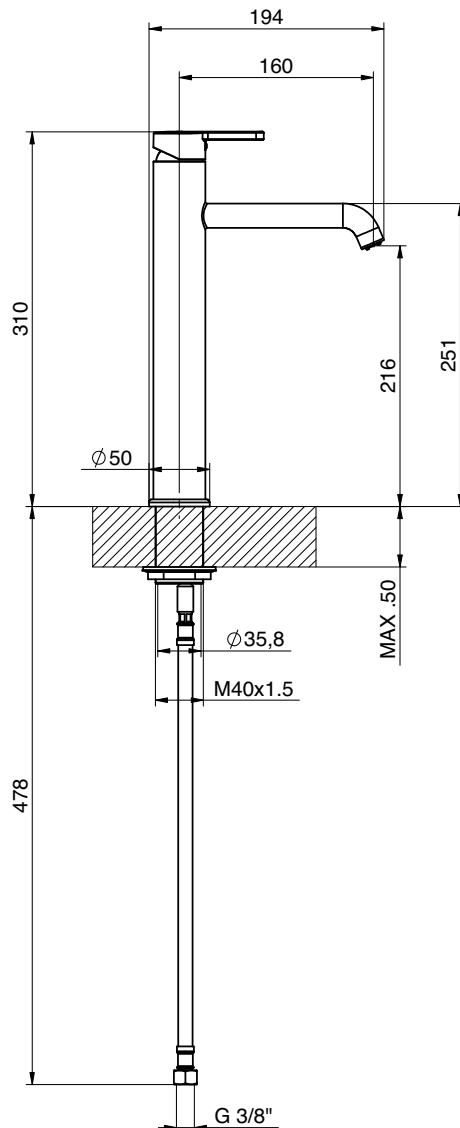



Modello Model	Codice Code	Codice Prodotto Product Code	Descrizione Description	Finitura Finishing
FLY 	F09SST	411496901	Miscelatore monocomando alto per lavabo, con scarico click clack da 1"1/4	Wash basin mixer Tall with 1" 1/4 click clack waste CROMO
FLY 	F09SST W1	411496906	Miscelatore monocomando alto per lavabo, con scarico click clack da 1"1/4 con leva colorata	RAL 9003
	F09SST B1	411496903		RAL 9004
	F09SST NB1	411496904		RAL 5026
	F09SST PG1	411496905		RAL 7036
	F09SST WB1	411496907		RAL 5021
FLY 	F09SS	411496902	Miscelatore monocomando alto per lavabo, senza scarico	Wash basin mixer Tall without waste CROMO
FLY 	F09SS W1	411496911	Miscelatore monocomando alto per lavabo, senza scarico, con leva colorata	RAL 9003
	F09SS B1	411496908		RAL 9004
	F09SS NB1	411496909		RAL 5026
	F09SS PG1	411496910		RAL 7036
	F09SS WB1	411496912		RAL 5021

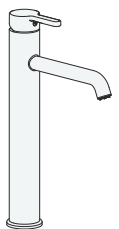

Cromo
Chrome

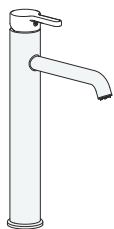

Bianco
White
W1 - RAL 9003



Nero
Black
B1 - RAL 9004



Blu
Night blue
NB1 - RAL 5026



Grigio platino
Platinum Grey
PG1 - RAL 7036



Verde acqua
Water blue
WB1 - RAL 5021



TIEMME Raccorderie S.p.A.

Via Cavallera 6/A (Loc. Barco) - 25045 Castegnato (Bs) - Italy
Tel +39 030 2142211 R.A. - Fax +39 030 2142206
info@tiemme.com - www.tiemme.com